

J10C3266

932 E 330 P  
CASE ASSY COMPRESSOR-FWD  
719A1PQ (9802)

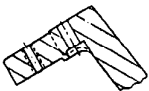

TOP VIEW OF BLADE RING GROOVES



SECTION C-5 (4-2.5H)

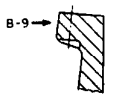

SECTION B-9 (4-2.5H)



VIEW A-9 (4-2.5H)

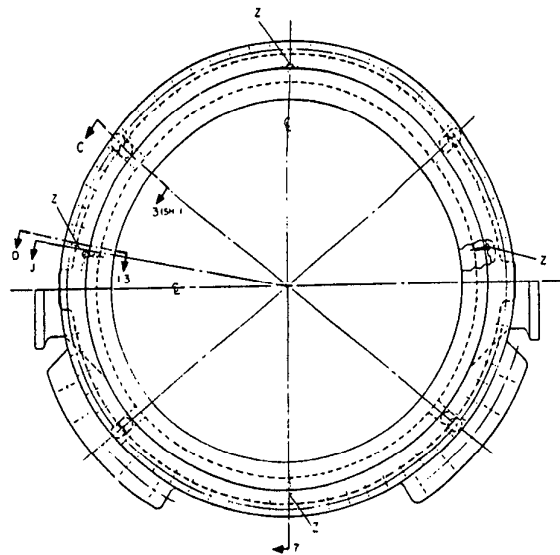

VIEW J-3 (4-7.5H)

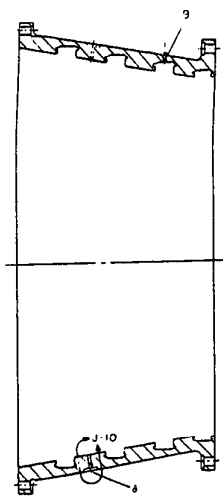

SECTION J-3 (4-7.5H)

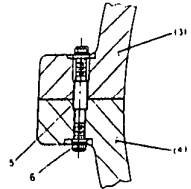

SECTION E-10 (4-6.2.5H)



SECTION D-13 (4-7.5H)

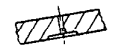

SECTION I-10 (4-7.5H)

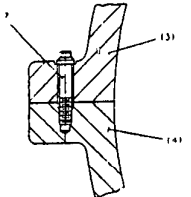

SECTION M-2 (4-3.5H)

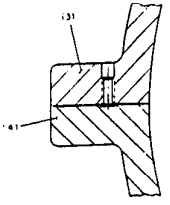

SECTION M-5 (4-8.5H)

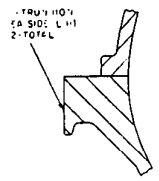

SECTION M-9 (4-7.5H)

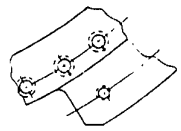

VIEW N-10 (4-3.5H)

113

932 E 330 P  
719A1PQ (9802)